

VINGTOR STENTOFON

Turbine Industrial Intercoms

Mounting Manual

Contents of this Delivery

 **NOTE** The unit comes with 5 blind plugs already mounted. The front frame is fastened with 2 socket-head cap M6 screws.



TFIE-1 1008122010



TFIE-2 1008122020



TFIE-6 1008122060



1 Cable Gland M20 1P68





1 Cable Gland M16 1P68



10 socket-head cap M6 screws
(+ 2 fastened to front frame)





This Manual

Important Notes before Mounting

-  Improper installation and operation of the unit will result in the invalidation of the warranty.
-  The enclosure/housing must not be opened when the unit is powered.
-  The installation and connection of units may only be carried out by qualified/approved personnel

General Mounting Considerations

When the unit is mounted directly onto a wall or mounting plate, it shall rest only on the fastening points provided for this purpose. The surface must be even and flat.

-  The unit must be mounted on a surface to prevent access from the rear of the unit.
-  Do not use countersunk screws.
-  Due to the enclosure material, use as low a tightening torque as possible when mounting the unit to the surface (1.5 Nm max.)
-  Washers are recommended.
-  Do not use more than 2.5 Nm torque when fastening the 12 screws into the front frame.

On Mounting Plate or Column - recommended screws:
M5 x 20 or 25 with Philips head DIN7985 or Torx.
Head diameter: 10 mm.

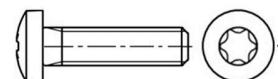

On Wall - recommended screws:
Panhead – DIN7981 for plug or wooden wall, etc.
Head diameter: 10.8 B5.5 x 38 or 45 mm.



Dimensions

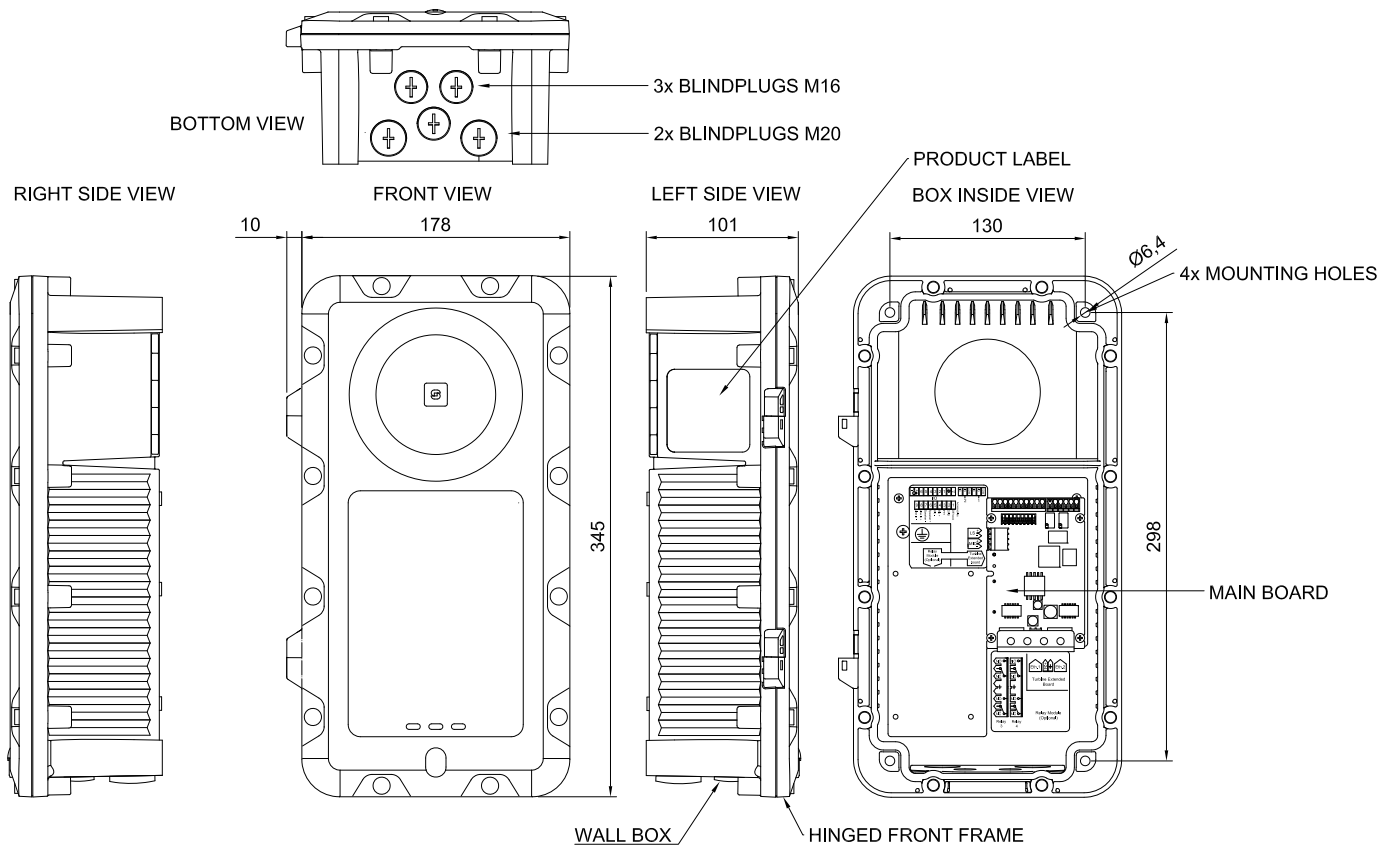

Opening the Enclosure

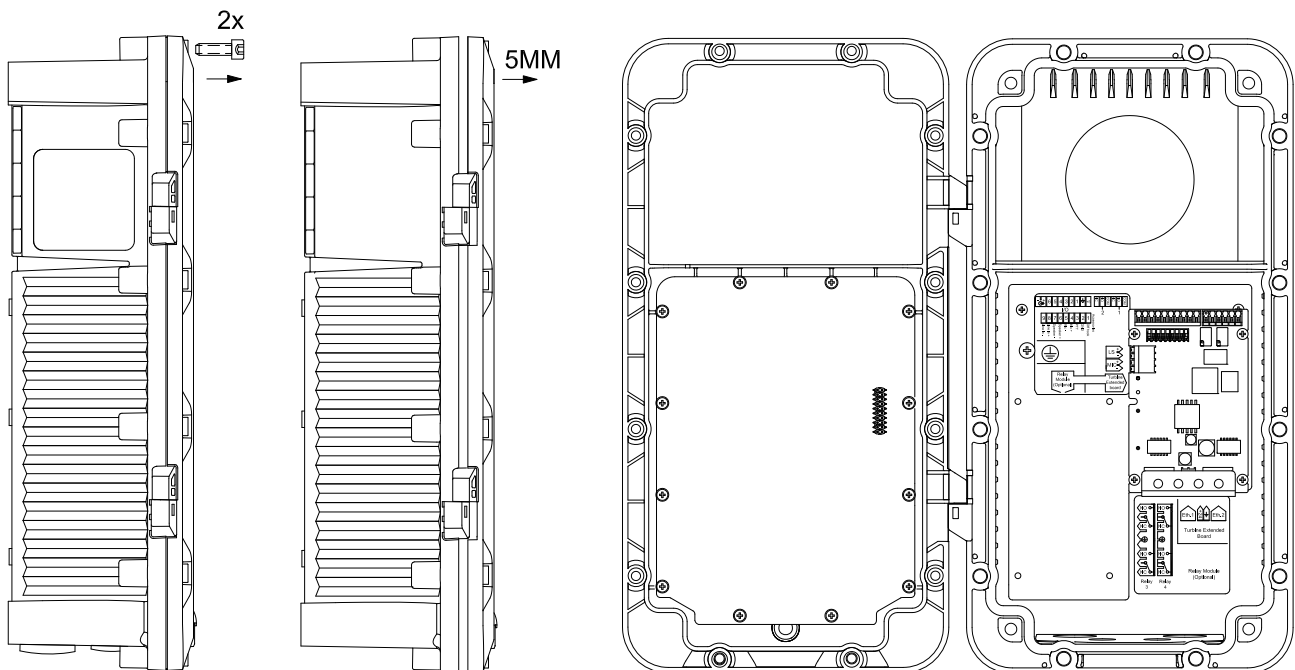

1 Loosen the 2 screws securing the front frame to the on-wall box.

2 Open the enclosure by pulling the front frame out 5 mm, keeping it parallel to the on-wall box. This is necessary to get clearing for the hinges.

3 Pull the right side of the front frame to fully open the enclosure. Do NOT open the enclosure to the extent that cables between the front and back parts are pulled tight.

Mounting the Unit

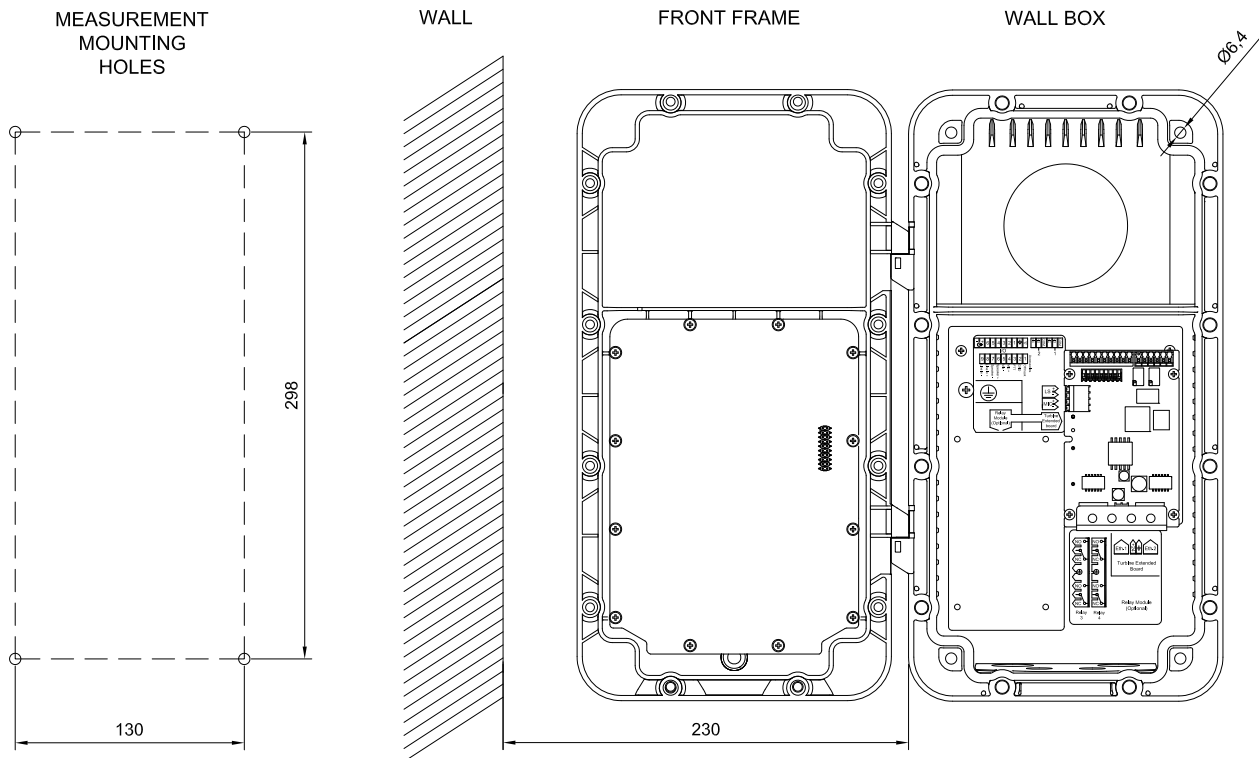

4 Preparation for Drilling

The four mounting holes in the on-wall box are Ø6.4 mm. Distance: 298 x 130 mm. Size of hole to be drilled depends on whether it is wall or column mounting.

5 Location

Make sure there is a clearance of minimum 230 mm on the left for frame movement.

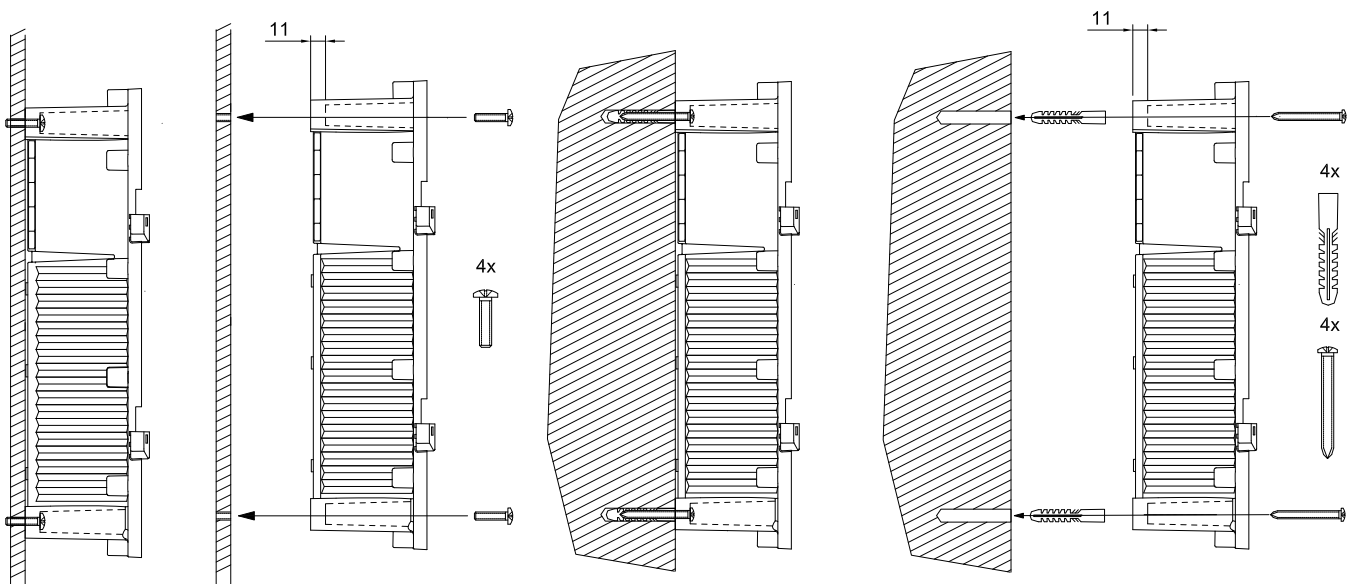

6 Mounting Plate or Column

Fix the unit to mounting plate or column with 4 screws that fit the 4 screw holes in each corner of on-wall box (6.4 mm diameter). Use M5 x 20 or 25 with Philips head DIN7985 or Torx. Head diameter: 10 mm.

7 Wall

Fix the unit to the wall with 4 screws that fit the 4 screw holes in each corner of the on-wall box (6.4 mm diameter). Use Panhead – DIN7981 screw for plug or wooden wall. Head diameter: 10.8 B5.5 x 38 or 45 mm.

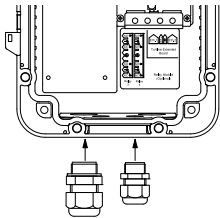

8 Mounting Cable Gland

Remove two blind plugs and insert one M16 and one M20 cable glands. Make sure to tighten sufficiently to attain IP66 rating for watertightness but be aware of plastic material limitations.

9 Fastening Front Frame

Do NOT use more than 2.5 Nm torque when fastening the 12 screws into the front frame.

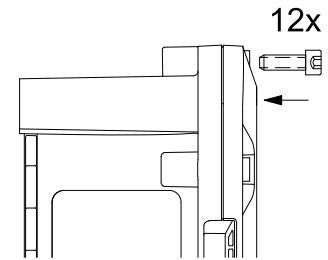

- In order to ensure the required minimum degree of protection, the cable glands must be tightened securely.
- Over-tightening can impair the degree of protection and damage the unit.
- When tightening the cap nut of a cable gland, a suitable tool shall be used to prevent the gland from twisting.

Electrical Connections & Configuration

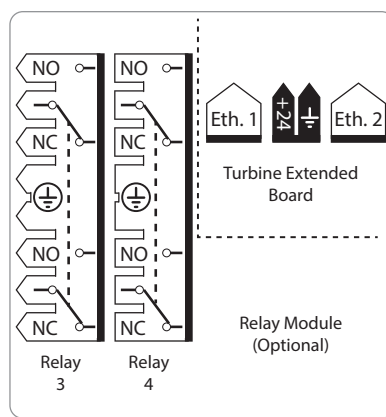
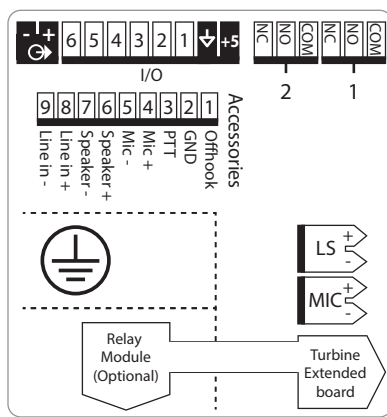

For complete documentation on TFIE intercom connections and configuration, see *Turbine Stations Configuration Manual*, Doc. no. A100K11194.

Accessories & Spare Parts

Item Number	Item Name	Item Description
2330040026	AK5850HS	Ex-Approved Headset with plug
1008140225	TA-22B	Plugbox with PTT Button and 10m Cable for Headset
1008140230	TA-23	Handset with PTT for TFIE/EAPII
1023533311	EMMAI-1H	Exigo Handheld Industrial Microphone
1023533312	EMMAI-2H	Exigo Handheld Industrial Microphone - Compact
1008140100	TA-10	Connection board with relays for TFIE/EAPII
1008140260	TA-26	Cable gland kit (10x) for TFIE/EAPII
1023594100	EGA-1	Button Protection Covers (10x) for TFIE/EAPII
1008140250	TA-25	M6 screw kit for TFIE/EAPII

Related Documentation

Document No.	Documentation
A100K11194	Turbine Stations Configuration Manual
A100K11564	TA-22B Connection Manual
A100K11565	EMMAI-1H Connection Manual
A100K11566	EMMAI-2H Connection Manual
A100K11567	TA-23 Connection Manual
A100K11457	AutoCAD Dwg. TFIE-1 Turbine Industrial IP and SIP Intercom Station
A100K11503	AutoCAD Dwg. TFIE-2 Turbine Industrial IP and SIP Intercom Station
A100K11754	AutoCAD Dwg. TFIE-6 Turbine Industrial IP and SIP Intercom Station

DOC NO.

A100K11575

DATE

Rev.01 27.09.2017

www.vingtor-stentofon.com

